

DEVICE PERFORMANCE SPECIFICATION

Revision 1.0 MTD/PS-1027

January 29, 2007

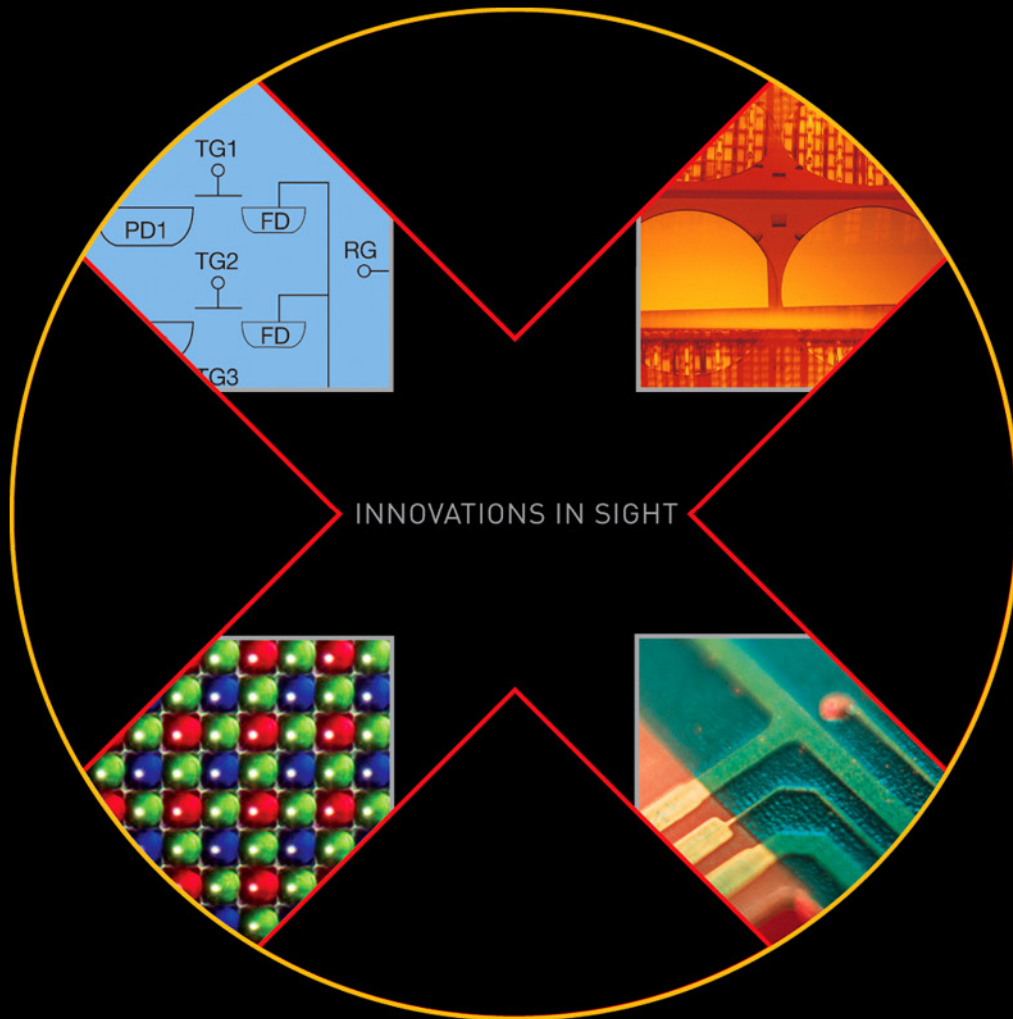

KODAK KAI-16000 IMAGE SENSOR

4872(H) X 3248(V) INTERLINE CCD IMAGE SENSOR

TABLE OF CONTENTS

Summary Specification 4
 Description 4
 Features..... 4
 Applications 4
Ordering Information 5
Device Description 6
 Architecture 6
 Pin Description and Physical Orientation..... 7
Imaging Performance 8
 Typical Operational Conditions 8
 Specifications 8
Typical Performance Curves 10
 Monochrome with Microlens Quantum Efficiency 10
 Monochrome without Microlens Quantum Efficiency..... 10
 Color with Microlens Quantum Efficiency..... 11
 Angular Quantum Efficiency 12
Defect Definitions..... 13
 Operational Conditions..... 13
 Specifications 13
Test Definitions 14
 Test Regions of Interest 14
 OverClocking 14
 Tests..... 15
Operation 16
 Absolute Maximum Ratings 16
 Maximum Voltage Ratings Between Pins 16
 Power Up Sequence 16
 DC Bias Operating Conditions 16
 AC Operating Conditions 17
 Clock Levels..... 17
 Clock Line Capacitances 17
Timing 18
 Requirements and Characteristics 18
 Main Timing – Continuous Mode 18
 Frame Timing – Continuous Mode 19
 Line Timing Continuous Mode 20
 Line Timing Single Output..... 20
 Line Timing Double Output 20
 Line Timing Detail Single Output 21
 Line Timing Detail Edge Alignment 21
 Pixel Timing 22
 Fast Line Dump Timing..... 23
 Electronic Shutter Timing..... 24
 Electronic Shutter Integration Time Definition 24
Storage and Handling 25
 Storage Conditions..... 25
 ESD 25
 Cover Glass Care and Cleanliness 25

Environmental Exposure.....	25
Soldering Recommendations	25
Mechanical Drawings.....	26
Completed Assembly	26
Cover Glass.....	28
Glass Transmission.....	29
Quality Assurance and Reliability.....	30
Quality Strategy	30
Replacement	30
Liability of the Supplier	30
Liability of the Customer.....	30
Reliability	30
Test Data Retention.....	30
Mechanical.....	30
Warning: Life Support Applications Policy.....	30
Revision Changes.....	30

TABLE OF FIGURES

Figure 1: Sensor Architecture	6
Figure 2: Package Pin Designations - Top View	7
Figure 3: Monochrome with Microlens Quantum Efficiency.....	10
Figure 4: Monochrome without Microlens Quantum Efficiency.....	10
Figure 5: Color with Microlens Quantum Efficiency.....	11
Figure 6: Monochrome with Microlens Angular Quantum Efficiency.....	12
Figure 7: Overclock Regions of Interest.....	14
Figure 8: Main Timing - Continuous Mode.....	18
Figure 9: Framing Timing	19
Figure 10: Line Timing Single Output.....	20
Figure 11: Line Timing Dual Output	20
Figure 12: Line Timing Detail Single Output.....	21
Figure 13: Line Timing Detail Edge Alignment.....	21
Figure 14: Pixel Timing	22
Figure 15: Fast Line Dump Timing.....	23
Figure 16: Electronic Shutter Timing	24
Figure 17: Integration Time Definition	24
Figure 18: Completed Assembly (1 of 2)	26
Figure 19: Completed Assembly (2 of 2)	27
Figure 20: Glass Drawing	28
Figure 21: Glass Transmission.....	29

SUMMARY SPECIFICATION

KODAK KAI-16000 IMAGE SENSOR

4872 (H) X 3248 (V) INTERLINE TRANSFER PROGRESSIVE SCAN CCD

DESCRIPTION

The KODAK KAI-16000 is an interline transfer CCD offering 16 million pixels at up to 3 frames per second through 2 outputs. This image sensor is organized into an array of 4,872(H) x 3,248(V) with 7.4 micron square pixels and full 35mm optical format. As an interline transfer CCD, the KAI-16000 includes additional features such as progressive scan readout, electronic shutter, low noise, high dynamic range, and blooming suppression. These features make the KAI-16000 the perfect sensor for applications in Industrial, Aerial, Security, and Scientific markets.

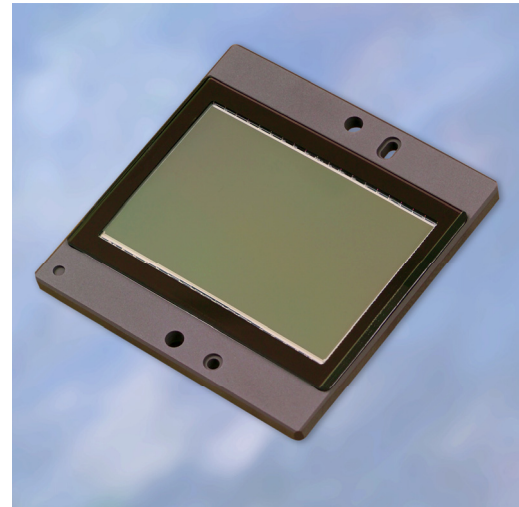

FEATURES

- 16 Million pixel resolution
- Electronic shutter
- 35mm Optical format
- Progressive scan readout
- High sensitivity
- Fast Frame rate
- >60 dB dynamic range

APPLICATIONS

- Industrial
- Aerial Photography
- Security
- Scientific

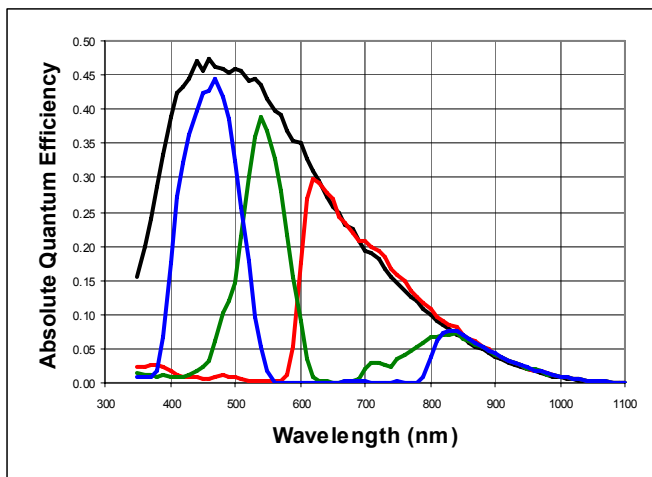

Parameter	Typical Value
Architecture	Interline CCD; Progressive Scan
Total Number of Pixels	4960 (H) x 3324 (V) = 16.6M
Number of Effective Pixels	4904 (H) x 3280 (V) = 16.1M
Number of Active Pixels	4872 (H) x 3248 (V) = 15.8M
Pixel Size	7.4 μ m (H) x 7.4 μ m (V)
Active Image Size	36.1 mm (H) x 24.0 mm (H) 43.3 mm (diagonal)
Aspect Ratio	3:2
Number of Outputs	1 or 2
Saturation Signal	30,000 electrons
Output Sensitivity	30 μ V/e
Quantum Efficiency KAI-16000-AXA (500nm)	45%
Quantum Efficiency KAI-16000-CXA R(630nm), G(540nm), B(470nm)	42%, 37%, 30%
Read Noise (f=30MHz)	16 electrons
Dark Current	< 0.5 nA/cm ²
Dark Current Doubling Temperature	7 $^{\circ}$ C
Dynamic Range	65 dB
Charge Transfer Efficiency	0.99999
Blooming Suppression	> 100X
Smear	< -80 dB
Image Lag	< 10 electrons
Maximum Data Rate	30 MHz per channel
Package	40 pin Pin Grid Array
Cover Glass	AR coated, 2 sides

All parameters above are specified at T = 40 $^{\circ}$ C

ORDERING INFORMATION

Catalog Number	Product Name	Description	Marking Code
4H0856	KAI-16000-AAA-JR-B1	Monochrome, No Microlens, PGA Package, Taped Clear Cover Glass with AR coating (2 sides), Grade 1	KAI-16000-AAA (Serial Number)
4H0857	KAI-16000-AAA-JR-B2	Monochrome, No Microlens, PGA Package, Taped Clear Cover Glass with AR coating (2 sides), Grade 2	
4H0858	KAI-16000-AAA-JR-AE	Monochrome, No Microlens, PGA Package, Taped Clear Cover Glass with AR coating (2 sides), Engineering Grade	
4H0850	KAI-16000-AXA-JD-B1	Monochrome, Special Microlens, PGA Package, Clear Cover Glass with AR coating (both sides), Grade 1	KAI-16000-AXA (Serial Number)
4H0851	KAI-16000-AXA-JD-B2	Monochrome, Special Microlens, PGA Package, Clear Cover Glass with AR coating (both sides), Grade 2	
4H0852	KAI-16000-AXA-JD-AE	Monochrome, Special Microlens, PGA Package, Clear Cover Glass with AR coating (both sides), Engineering Grade	
4H0853	KAI-16000-CXA-JD-B1	Color (Bayer RGB), Special Microlens, PGA Package, Clear Cover Glass with AR coating (both sides), Grade 1	KAI-16000-CXA (Serial Number)
4H0854	KAI-16000-CXA-JD-B2	Color (Bayer RGB), Special Microlens, PGA Package, Clear Cover Glass with AR coating (both sides), Grade 2	
4H0855	KAI-16000-CXA-JD-AE	Color (Bayer RGB), Special Microlens, PGA Package, Clear Cover Glass with AR coating (both sides), Engineering Grade	

Please see ISS Application Note "Product Naming Convention" (MTD/PS-0892) for a full description of naming convention used for KODAK image sensors

Address all inquiries and purchase orders to:

Image Sensor Solutions
Eastman Kodak Company
Rochester, New York 14650-2010

Phone: (585) 722-4385
Fax: (585) 477-4947
E-mail: imagers@kodak.com

Kodak reserves the right to change any information contained herein without notice. All information furnished by Kodak is believed to be accurate.

DEVICE DESCRIPTION

ARCHITECTURE

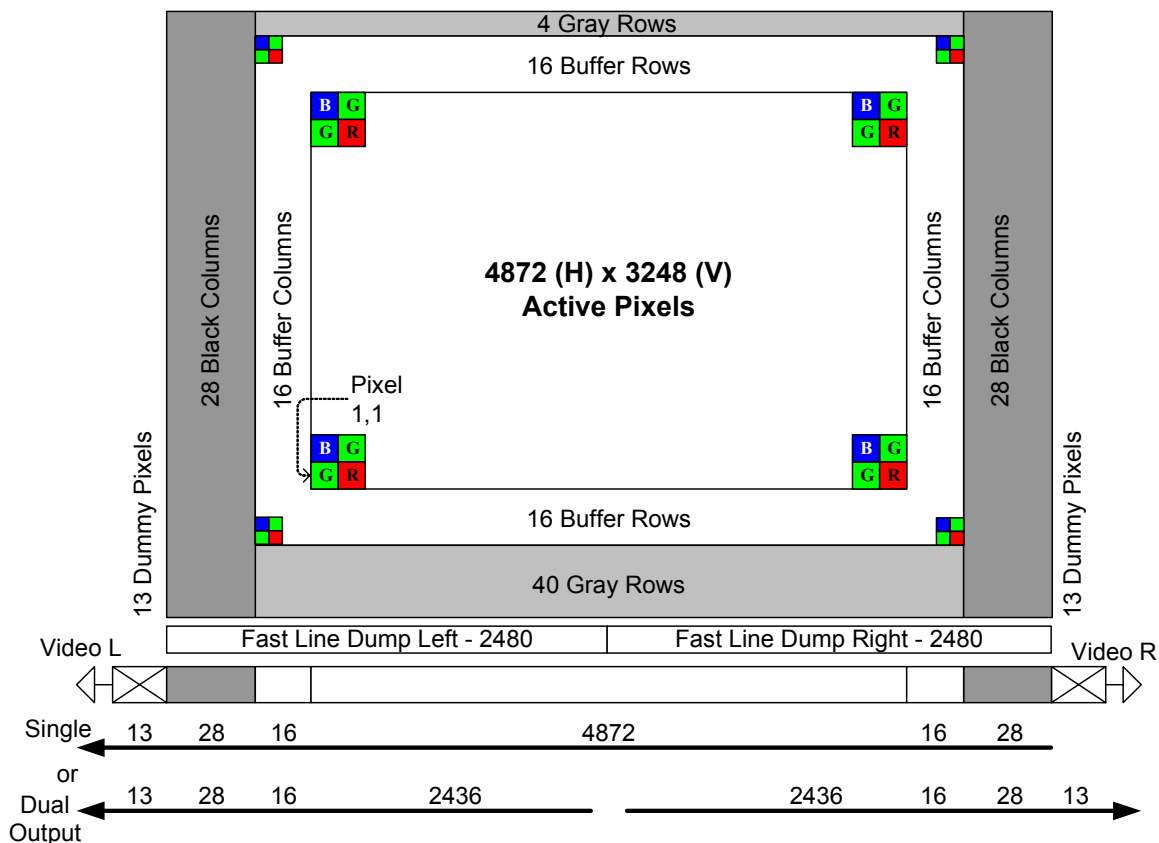

Figure 1: Sensor Architecture

There are 40 light shielded gray rows followed 3280 photoactive rows and finally 4 more light shielded gray rows. The first 16 and the last 16 photoactive rows are buffer rows giving a total of 3248 lines of image data.

In the single output mode all pixels are clocked out of the Video L output in the lower left corner of the sensor. The first 13 empty pixels of each line do not receive charge from the vertical shift register. The next 28 pixels receive charge from the left light shielded edge followed by 4904 photosensitive pixels and finally 28 more light shielded pixels from the right edge of the sensor. The first 16 and last 16 photosensitive pixels are buffer pixels giving a total of 4872 pixels of image data.

In the dual output mode the clocking of the right half of the horizontal CCD is reversed. The left half of the image is clocked out Video L and the right half of the image is

clocked out Video R. For the Video L each row consists of 13 empty pixels followed by 28 light shielded pixels followed by 2452 photosensitive pixels. For the Video R each row consists of 13 empty pixels followed by 28 light shielded pixels followed by 2452 photosensitive pixels. When reconstructing the image, data from Video R will have to be reversed in a line buffer and appended to the Video L data.

The gray rows are not entirely dark and so should not be used for a dark reference level. Use the dark columns on the left or right side of the image sensor as a dark reference.

Of the dark columns, the first and last dark columns should not be used for determining the zero signal level. Some light does leak into the first and last dark columns.

PIN DESCRIPTION AND PHYSICAL ORIENTATION

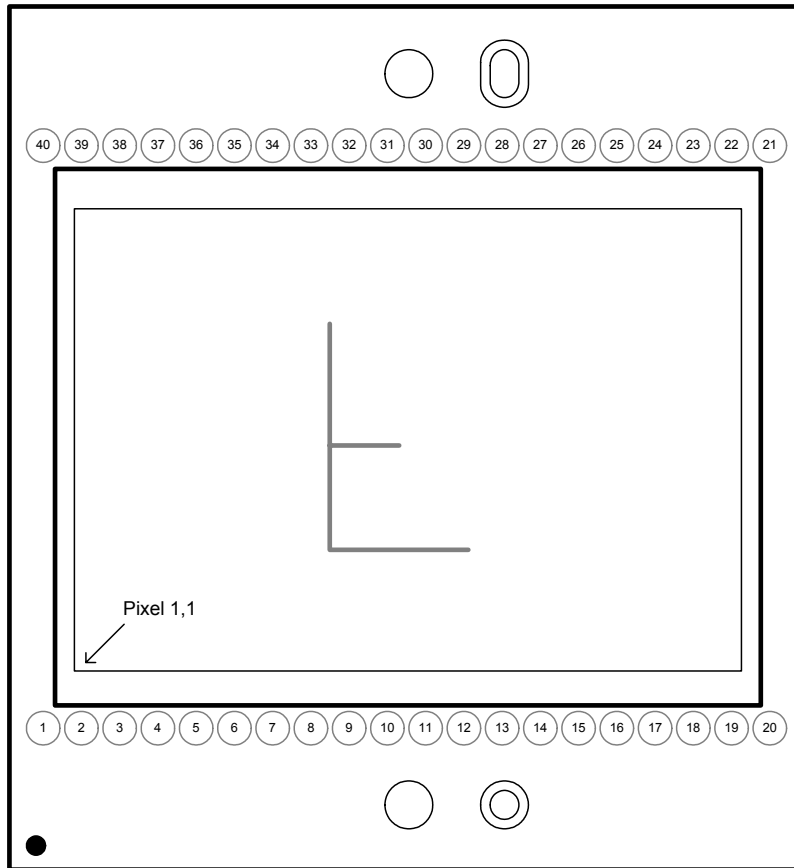

Figure 2: Package Pin Designations - Top View

Pin	Name	Description
1	VOUTL	Video Output, Left
2	VDDL	Vdd, Left
3	GND	Ground
4	RESETL	Reset Gate, Left
5	HLASTL	Horizontal Clock, Last Stage, Left
6	H2BL	Horizontal Clock, Phase 2, Barrier, Left
7	H1BL	Horizontal Clock, Phase 1, Barrier, Left
8	H1SL	Horizontal Clock, Phase 1, Storage, Left
9	H2SL	Horizontal Clock, Phase 2, Storage, Left
10	ESD	ESD Protection Disable
11	GND	Ground
12	H2SR	Horizontal Clock, Phase 2, Storage, Right
13	H1SR	Horizontal Clock, Phase 1, Storage, Right
14	H1BR	Horizontal Clock, Phase 1, Barrier, Right
15	H2BR	Horizontal Clock, Phase 2, Barrier, Right
16	HLASTR	Horizontal Clock, Last Stage, Right
17	RESETR	Reset Gate, Right
18	GND	Ground
19	VDDR	Vdd, Right
20	VOUTR	Video Output, Right

Pin	Name	Description
40	FDGL	Fast Line Dump Gate, Left
39	RDL	Reset Drain, Left
38	SUB	Substrate
37	GND	Ground
36	V1	VCCD Gate 1, Phase 2
35	V5	VCCD Gate 5, Phase 2
34	V9	VCCD Gate 9, Phase 2
33	V3	VCCD Gate 3, Phase 2
32	V7	VCCD Gate 7, Phase 2
31	V11	VCCD Gate 11, Phase 2
30	V2	VCCD Gate 2, Phase 1
29	V6	VCCD Gate 6, Phase 1
28	V10	VCCD Gate 10, Phase 1
27	V4	VCCD Gate 4, Phase 1
26	V8	VCCD Gate 8, Phase 1
25	V12	VCCD Gate 12, Phase 1
24	GND	Ground
23	SUB	Substrate
22	RDR	Reset Drain, Right
21	FDGR	Fast Line Dump Gate, Right

IMAGING PERFORMANCE

TYPICAL OPERATIONAL CONDITIONS

Unless otherwise noted, the Specifications are measured using the following conditions.

Description	Condition	Notes
Frame Time	908 msec	1
Horizontal Clock Frequency	20 MHz	
Light Source	Continuous red, green and blue illumination centered at 450, 530 and 650 nm	2,3
Operation	Nominal operating voltages and timing	

Notes:

1. Electronic shutter is not used. Integration time equals frame time.
2. LEDs used: Blue: Nichia NLPB500, Green: Nichia NSPG500S and Red: HP HLMP-8115.
3. For monochrome sensor, only green LED used.

SPECIFICATIONS

Description	Symbol	Min.	Nom.	Max.	Units	Temperature Tested At (°C)	Notes	Test	Sample Plan ⁷
Global Non-Uniformity		n/a	2.5	5.0	%rms	27, 40	1	1	Die
Maximum Photoresponse Nonlinearity	NL	n/a	2		%		2, 3		Design
Maximum Gain Difference Between Outputs	ΔG	n/a	10		%		2, 3		Design
Max. Signal Error due to Nonlinearity Dif.	ΔNL	n/a	1		%		2, 3		Design
Horizontal CCD Charge Capacity	HNe		100		ke ⁻				Design
Vertical CCD Charge Capacity	VNe		50		ke ⁻	27, 40			Die
Photodiode Charge Capacity	PNe	28	30		ke ⁻	27, 40	4		Die
Horizontal CCD Charge Transfer Efficiency	HCTE	0.99999		n/a					Design
Vertical CCD Charge Transfer Efficiency	VCTE	0.99999		n/a					Design
Photodiode Dark Current	l _{pd}	n/a	40	350	e ⁻ /p/s	40			Die
Photodiode Dark Current	l _{pd}	n/a	0.01	0.1	nA/cm ²	40			Die
Vertical CCD Dark Current	l _{vd}	n/a	400	1711	e ⁻ /p/s	40			Die
Vertical CCD Dark Current	l _{vd}	n/a	0.12	0.5	nA/cm ²	40			Die
Dark Current Doubling Temperature	ΔT	n/a	7	n/a	°C				Design
Image Lag	Lag	n/a	<10	50	e ⁻				Design
Antiblooming Factor	X _{ab}	100	300	n/a					Design
Vertical Smear	S _{mr}	n/a	-80	-75	dB				Design
Read Noise	n _{e-τ}		16		e ⁻ rms		5		Design
Dynamic Range	DR		65		dB		5, 6		Design
Output Amplifier DC Offset	V _{o_{dc}}	4	9.5	14	V	27, 40			Die
Output Amplifier Bandwidth	F _{-3db}		140		MHz				Design
Output Amplifier Impedance	R _{OUT}	100	130	200	Ohms	27, 40			Die
Output Amplifier Sensitivity	$\Delta V/\Delta N$		30		$\mu V/e^-$				Design

KAI-16000-AAA

Description	Symbol	Min.	Nom.	Max.	Units	Temperature Tested At (°C)	Notes	Test	Sample Plan ⁷
Peak Quantum Efficiency	QE _{max}		11	n/a	%				Design
Peak Quantum Efficiency Wavelength	λQE	n/a	500	n/a	nm				Design

KAI-16000-AXA

Description	Symbol	Min.	Nom.	Max.	Units	Temperature Tested At (°C)	Notes	Test	Sample Plan ⁷
Peak Quantum Efficiency	QE _{max}		45	n/a	%				Design
Peak Quantum Efficiency Wavelength	λQE	n/a	500	n/a	nm				Design

KAI-16000-CXA

Description	Symbol	Min.	Nom.	Max.	Units	Temperature Tested At (°C)	Notes	Test	Sample Plan ⁷
Peak Quantum Efficiency Blue Green Red	QE _{max}		42 37 30	n/a n/a n/a	%				Design
Peak Quantum Efficiency Wavelength Blue Green Red	λQE	n/a n/a n/a	470 540 630	n/a n/a n/a	nm				Design

n/a: not applicable

Notes:

1. Per color
2. Value is over the range of 10% to 90% of photodiode saturation.
3. Value is for the sensor operated without binning
4. The operating of the substrate voltage, VAB, will be marked on the shipping container for each device. The value of Vab is set such that the photodiode charge capacity is 30,000 electrons.
5. At 30 MHz.
6. Uses 20LOG(PNe/ n_{e-τ})
7. "Die" indicates a parameter that is measured on every sensor during the production testing. "Design" designates a parameter that is quantified during the design verification activity.

TYPICAL PERFORMANCE CURVES

MONOCHROME WITH MICROLENS QUANTUM EFFICIENCY

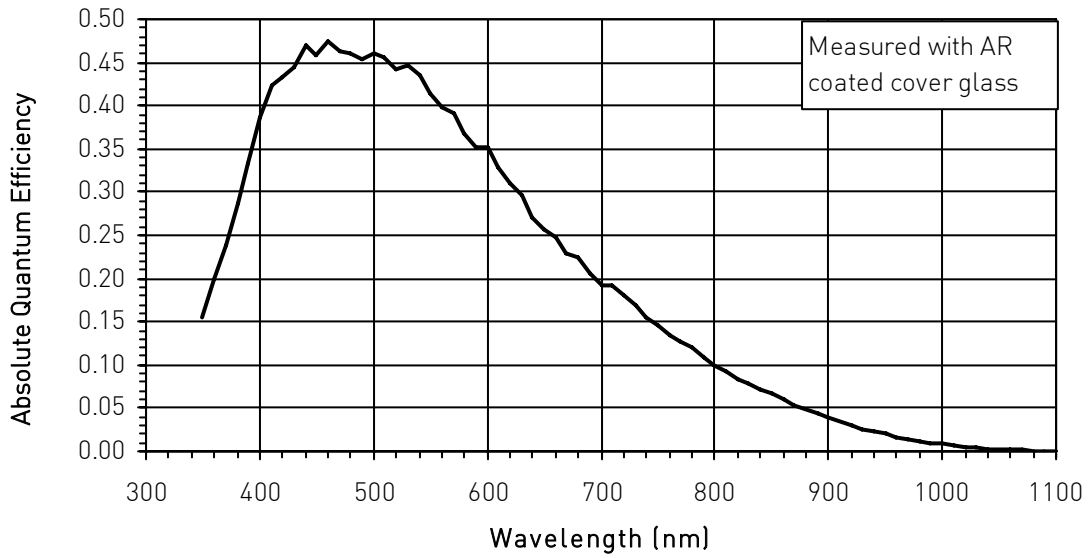

Figure 3: Monochrome with Microlens Quantum Efficiency

MONOCHROME WITHOUT MICROLENS QUANTUM EFFICIENCY

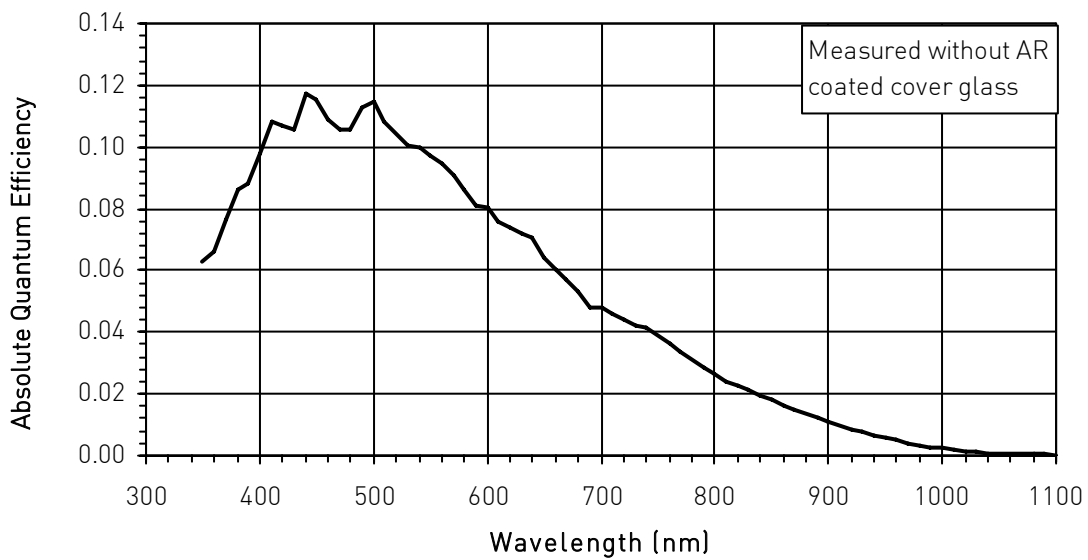

Figure 4: Monochrome without Microlens Quantum Efficiency

COLOR WITH MICROLENS QUANTUM EFFICIENCY

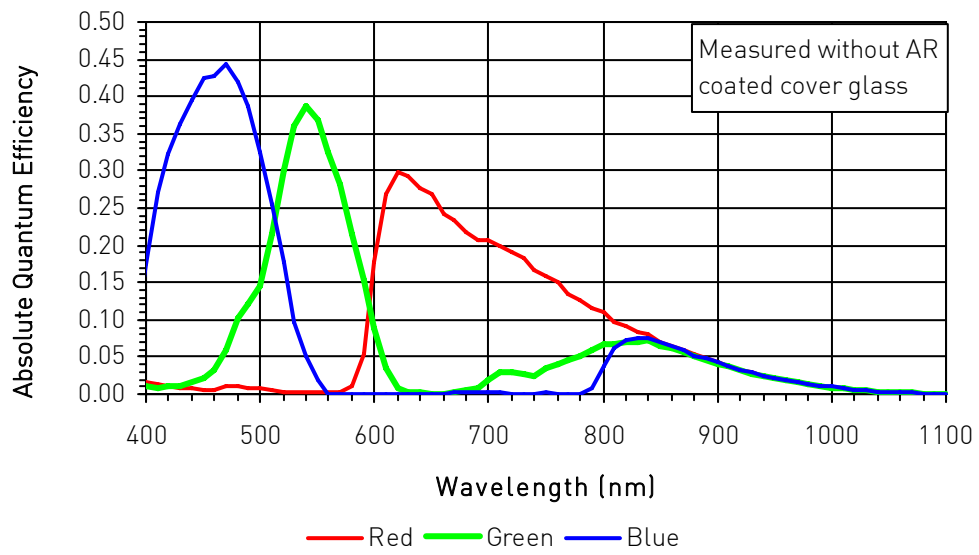

Figure 5: Color with Microlens Quantum Efficiency

ANGULAR QUANTUM EFFICIENCY

For the curves marked "Horizontal", the incident light angle is varied in a plane parallel to the HCCD.
For the curves marked "Vertical", the incident light angle is varied in a plane parallel to the VCCD.

Monochrome with Microlens

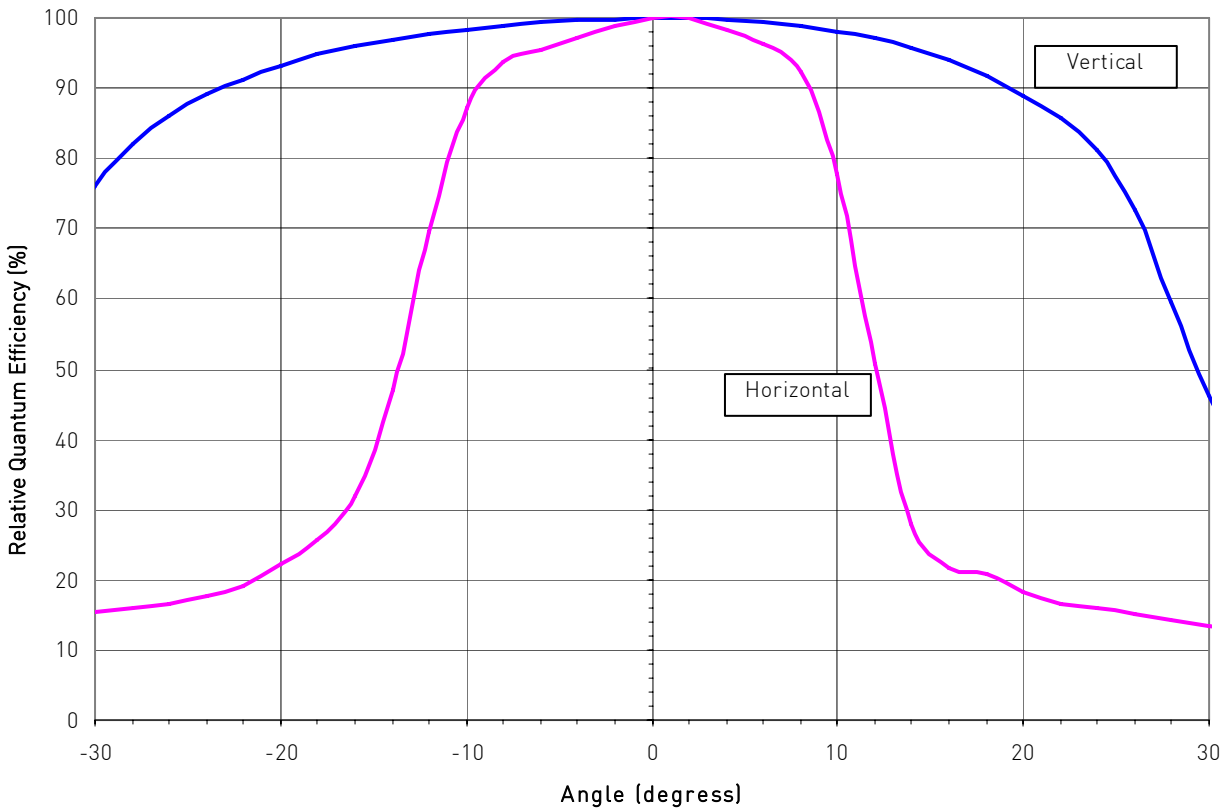

Figure 6: Monochrome with Microlens Angular Quantum Efficiency

DEFECT DEFINITIONS

OPERATIONAL CONDITIONS

All defect tests performed at $t_{int} = t_{frame} = 908$ msec

SPECIFICATIONS

Description	Definition	Class 1	Class 2 Monochrome	Class 2 Color	Notes	Test
Major dark field defective bright pixel	Defect ≥ 245 mV	150	300	300	2	2
Major bright field defective dark pixel	Defect $\geq 15\%$					3
Minor dark field defective bright pixel	Defect ≥ 126 mV	1500	3000	3000	3	2
Cluster defect	A group of 2 to "N" contiguous major defective pixels, but no more than "W" adjacent defects horizontally	30 N=20 W=4	30 N=20 W=4	30 N=20 W=4	1, 2	
Column defect	A group of more than 10 contiguous major defective pixels along a single column	0	4	15	1, 2	

Notes:

1. Column and cluster defects are separated by no less than two (2) pixels in any direction (excluding single pixel defects).
2. Tested at 27°C and 40°C.
3. Tested at 40°C.

Defect Map

The defect map supplied with each sensor is based upon testing at an ambient (27C) temperature. Minor point defects are not included in the defect map. All defective pixels are reference to pixel 1,1 in the defect maps.

TEST DEFINITIONS

TEST REGIONS OF INTEREST

Active Area ROI: Pixel 1, 1 to Pixel 4872,3248

Only the active pixels are used for performance and defect tests.

OVERCLOCKING

The test system timing is configured such that the sensor is overclocked in both the vertical and horizontal directions. See Figure 7 for a pictorial representation of the regions.

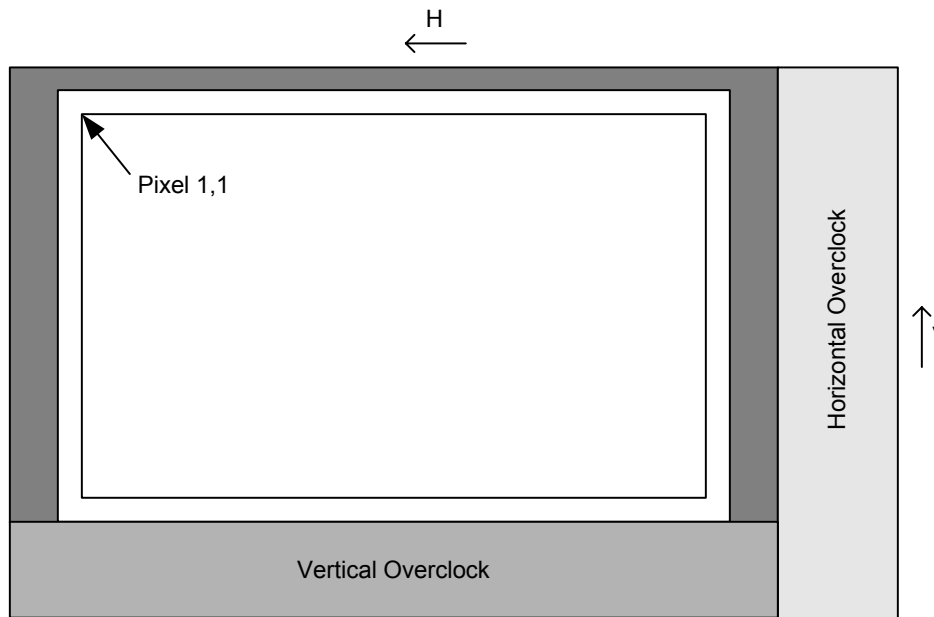

Figure 7: Overclock Regions of Interest

TESTS

1. Global Non-Uniformity

This test is performed with the imager illuminated to a level such that the output is at 70% of saturation (approximately 630 mV). Prior to this test being performed the substrate voltage has been set such that the charge capacity of the sensor is 900 mV. Global non-uniformity is defined as

$$\text{Global Non - Uniformity} = 100 * \left(\frac{\text{Active Area Standard Deviation}}{\text{Active Area Signal}} \right) \text{ Units: \%rms}$$

$$\text{Active Area Signal} = \text{Active Area Average} - \text{Horizontal Overclock Average}$$

2. Dark field defect test

This test is performed under dark field conditions. The sensor is partitioned into 384 sub regions of interest, each of which is 203 by 203 pixels in size. In each region of interest, the median value of all pixels is found. For each region of interest, a pixel is marked defective if it is greater than or equal to the median value of that region of interest plus the defect threshold specified in the "Defect Definitions" section.

3. Bright field defect test

This test is performed with the imager illuminated to a level such that the output is at approximately 630mV. Prior to this test being performed the substrate voltage has been set such that the charge capacity of the sensor is 900mV. The average signal level of all active pixels is found. The bright and dark thresholds are set as:

$$\text{Dark defect threshold} = \text{Active Area Signal} * \text{threshold}$$

$$\text{Bright defect threshold} = \text{Active Area Signal} * \text{threshold}$$

The sensor is then partitioned into 384 sub regions of interest, each of which is 203 by 203 pixels in size. In each region of interest, the average value of all pixels is found. For each region of interest, a pixel is marked defective if it is greater than or equal to the median value of that region of interest plus the bright threshold specified or if it is less than or equal to the median value of that region of interest minus the dark threshold specified.

Example for major bright field defective pixels:

- Average value of all active pixels is found to be 630 mV
- Dark defect threshold: $630\text{mV} * 15\% = 95 \text{ mV}$
- Bright defect threshold: $630\text{mV} * 15\% = 95 \text{ mV}$
- Region of interest #1 selected. This region of interest is pixels 1,1 to pixels 203, 203.
 - Median of this region of interest is found to be 630 mV.
 - Any pixel in this region of interest that is $\geq (630+95 \text{ mV}) 725 \text{ mV}$ in intensity will be marked defective.
 - Any pixel in this region of interest that is $\leq (630-95 \text{ mV}) 535 \text{ mV}$ in intensity will be marked defective.
- All remaining 384 sub regions of interest are analyzed for defective pixels in the same manner.

OPERATION

ABSOLUTE MAXIMUM RATINGS

Absolute maximum rating is defined as a level or condition that should not be exceeded at any time per the description. If the level or the condition is exceeded, the device will be degraded and may be damaged.

Description	Symbol	Minimum	Maximum	Units	Notes
Operating Temperature	T _{OP}	-50	70	°C	1
Humidity	RH	5	90	%	2
Output Bias Current	I _{out}	0.0	-40	mA	3
Off-chip Load	C _L		10	pF	

Notes:

- Noise performance will degrade at higher temperatures.
- T=25°C. Excessive humidity will degrade MTTF.
- Total for both outputs. Current is -20 mA for each output. Avoid shorting output pins to ground or any low impedance source during operation. Amplifier bandwidth increases at higher current and lower load capacitance at the expense of reduced gain (sensitivity). Operation at these values will reduce MTTF.

MAXIMUM VOLTAGE RATINGS BETWEEN PINS

Description	Minimum	Maximum	Units	Notes
RL, RR, H1SL, H1BL, H2SL, H2BL, H1SR, H1BR, H2SR, H2SR, HLASTL, HLASTR to ESD	0	17	V	
Pin to Pin with ESD Protection	-17	17	V	1
VDDL, VDDR to GND	0	25	V	

Notes:

- Pins with ESD protection are: RL, RR, H1SL, H1BL, H2SL, H2BL, H1SR, H1BR, H2SR, H2SR, HLASTL, and HLASTR

POWER UP SEQUENCE

- Substrate
- ESD Protection Disable
- All other clocks and biases

DC BIAS OPERATING CONDITIONS

Description	Symbol	Pins	Minimum	Nominal	Maximum	Units	Maximum DC Current (mA)	Notes
Reset Drain	RD	RDL, RDR	+11.5	+12.0	+12.0	V		
Output Amplifier Supply	VDD	VDDL, VDDR	+14.5	+15.0	+15.5	V		4
Ground	GND	GND	0.0	0.0	0.0	V		
Substrate	SUB	SUB	+8.0	VAB	+16.0	V		1
ESD Protection Disable	ESD	ESD	-9.25	-9.0	-8.75	V		2
Output Bias Current	I _{out}	VO _{UTL} , VO _{UTR}		-5.0	-10.0	mA		3

Notes:

- The operating of the substrate voltage, VAB, will be marked on the shipping container for each device. The value of Vab is set such that the photodiode charge capacity is 30,000 electrons.
- VESD must be at least 1 V more negative than H1_lo and H2_lo during sensor operation *AND* during camera power turn on.
- An output load sink must be applied to Vout to activate output amplifier.
- The maximum DC current is for one output unloaded. This is the maximum current that the first two stages of one output amplifier will draw. This value is with Vout disconnected.

AC OPERATING CONDITIONS

Clock Levels

Description	Pins	Symbol	Minimum	Nominal	Maximum	Units	Notes
Vertical CCD Clock High	V1, V3, V5, V7, V9, V11	V_2hi	+8.5	+9.0	+9.5	V	
Vertical CCD Clocks Midlevel	V1, V2, V3, V4, V5, V6, V7, V8, V9, V10, V11, V12	V_1mid, V_2mid	-0.2	0.0	+0.2	V	
Vertical CCD Clocks Low	V1, V2, V3, V4, V5, V6, V7, V8, V9, V10, V11, V12	V_1lo, V_2lo	-9.5	-9.0	-8.5	V	
Horizontal CCD Clocks Amplitude	H1SL, H1BL, H2SL, H2BL, H1SR, H1BR, H2SR, H2SR	H_amp	+4.5	+5.0	+5.5	V	
Horizontal CCD Clocks Low	H1SL, H1BL, H2SL, H2BL, H1SR, H1BR, H2SR, H2SR	H_lo	-5.0	-4.5	-4.0	V	
Horizontal Last CCD Amplitude	HLASTL, HLASTR	HLAST_amp	+4.5	+5.0	+5.5	V	
Horizontal Last CCD Low	HLASTL, HLASTR	HLAST_lo	-5.0	-4.5	-4.0	V	
Reset Clock Amplitude	RESETL, RESETR	R_amp	+4.5	+5.0	+5.5	V	
Reset Clock Low	RESETL, RESETR	R_lo	-3.0	-3.5	-2.5	V	
Electronic Shutter Voltage	SUB	Vshutter	+44	+48	+52	V	
Fast Dump High	FDL, FDR	FD_hi	+4.5	+5.0	+5.5	V	
Fast Dump Low	FDL, FDR	FD_lo	-9.5	-9.0	-8.5	V	

Clock Line Capacitances

Clocks	Capacitance	Units	Notes
Vertical CCD Phase 1 to GND	108	nF	1, 3
Vertical CCD Phase 2 to GND	118	nF	1, 4
Vertical CCD Phase 1 to Vertical CCD Phase 2	56	nF	3, 4
H1S to GND	27	pF	2
H2S to GND	27	pF	2
H1B to GND	13	pF	2
H2B to GND	4	pF	2
H1S to H2B and H2S	13	pF	2
H1B to H2B and H2S	13	pF	2
H2S to H1B and H1S	13	pF	2
H2B to H1B and H1S	13	pF	2
HLAST to GND	20	pF	2
RESET to GND	10	pF	
FD to GND	20	pF	

Notes:

- Gate capacitance to GND is voltage dependent. Value is for nominal VCCD clock voltages.
- For nominal HCCD clock voltages, these values are for half of the imager (H1SL, H1BL, H2SL, H2BL and H1BINL or H1SR, H1BR, H2SR, H2BR and H1BINR).
- Vertical CCD Phase 1: V2, V4, V6, V8, V10, V12
- Vertical CCD Phase 2: V1, V3, V5, V7, V9, V11

TIMING

REQUIREMENTS AND CHARACTERISTICS

Description	Symbol	Minimum	Nominal	Maximum	Units	Notes
VCCD to HCCD Delay	T_{HD}	4	6		μs	
VCCD Transfer Time	T_{VCCD}	4	6		μs	
HCCD to VCCD Delay	T_{HL}		50		ns	
Photodiode transfer time	T_{V3rd}	10	12		μs	
VCCD Pedestal time	T_{3P}	200	600		μs	
VCCD Delay	T_{3D}	12	20		μs	
VCCD Delay Before Pedestal	T_{DEI}		50		ns	
VCCD Delay Before 1 st Line	T_{D1L}	10	60		μs	
Reset Pulse time	T_R		3.25		ns	
VCCD to HCCD Delay – Shutter	T_{HDS}		6		μs	
Shutter Pulse time	T_S		4		μs	
Shutter Pulse delay	T_{SD}		1.5		μs	
HCCD Clock Period	T_H	33.3			ns	
VCCD rise/fall time	T_{VR}	0.2			μs	
Fast Dump Gate Leading Delay	T_{FDL}	0.5			μs	
Fast Dump Gate Trailing Delay	T_{FDT}	0.5			μs	
VCCD Line Clock Leading Edge Delay	T_{VL}	0.2	0.3	0.4	μs	
VCCD Line Clock Trailing Edge Delay	T_{VT}	0.0	0.2	0.4	μs	

MAIN TIMING – CONTINUOUS MODE

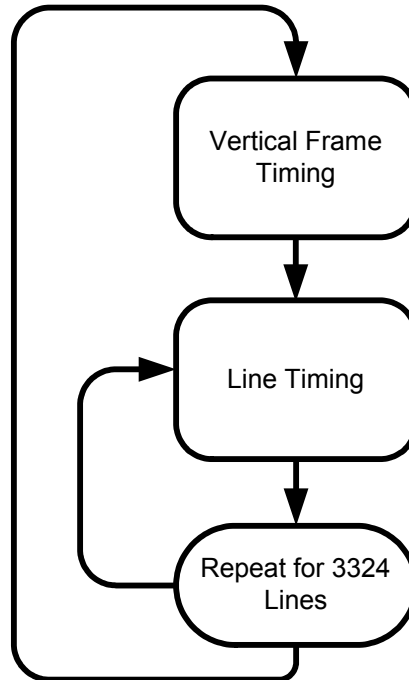

Figure 8: Main Timing - Continuous Mode

FRAME TIMING – CONTINUOUS MODE

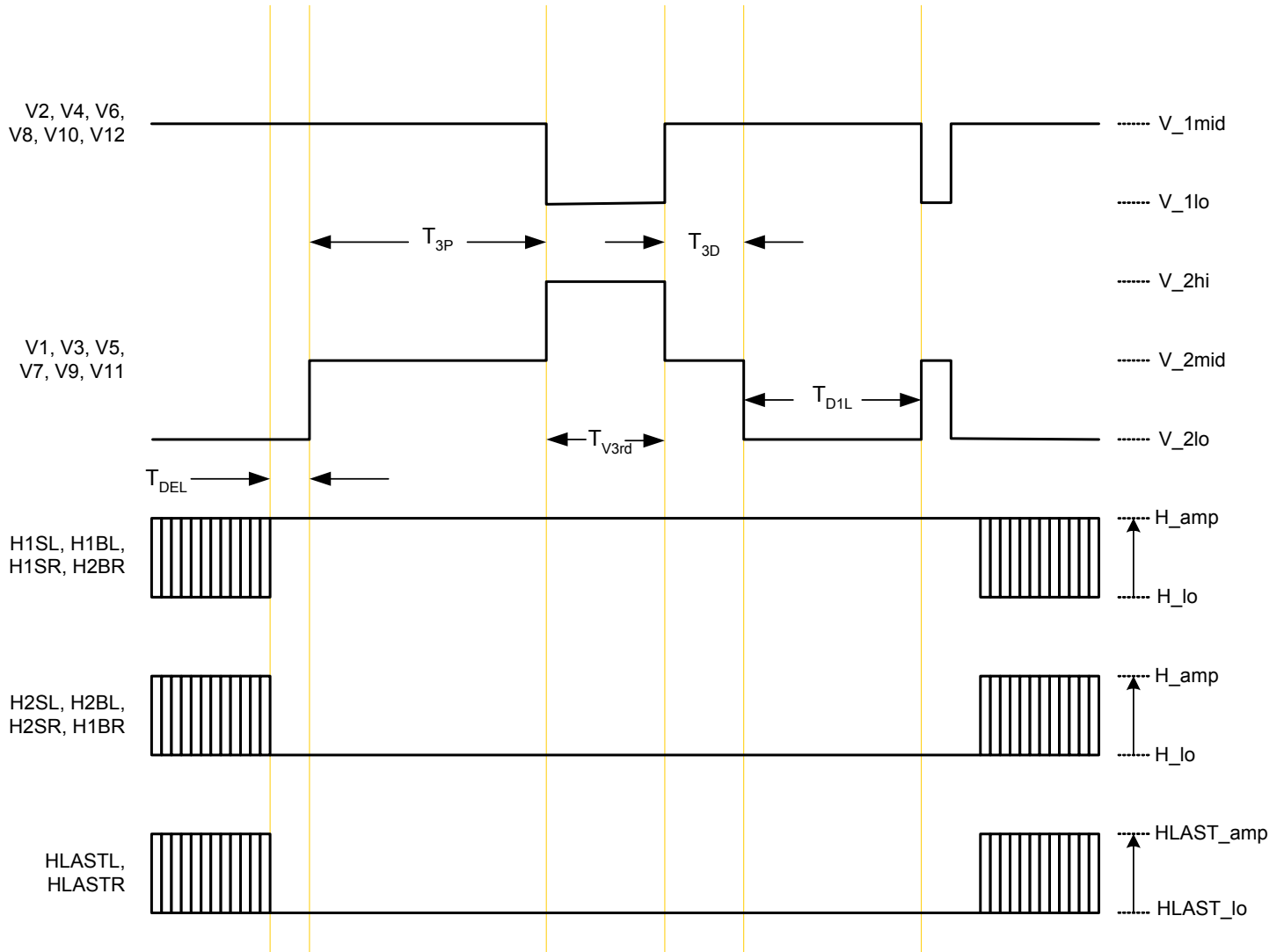

Figure 9: Framing Timing

LINE TIMING CONTINUOUS MODE

Line Timing Single Output

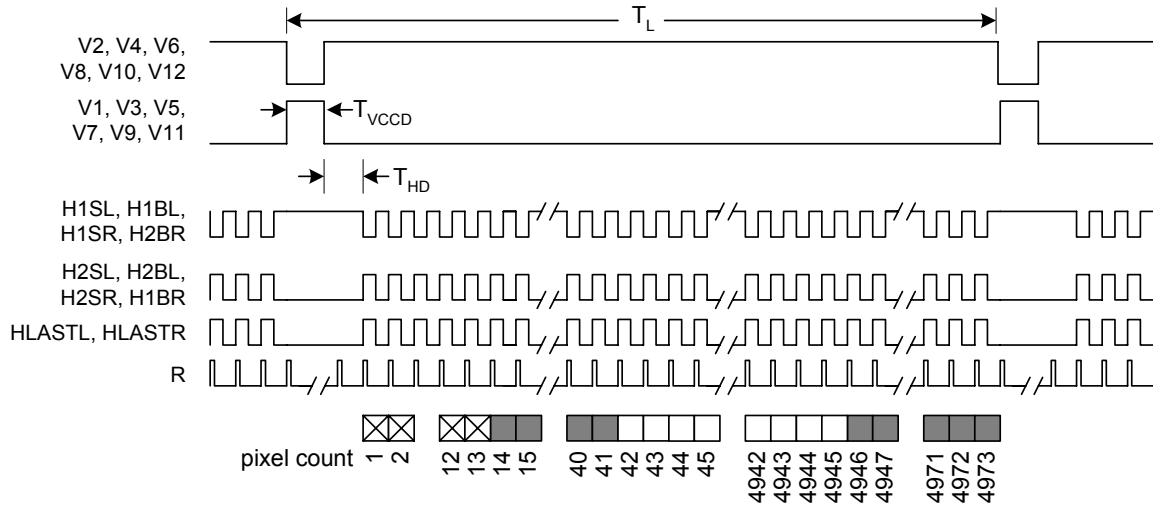

Figure 10: Line Timing Single Output

Line Timing Double Output

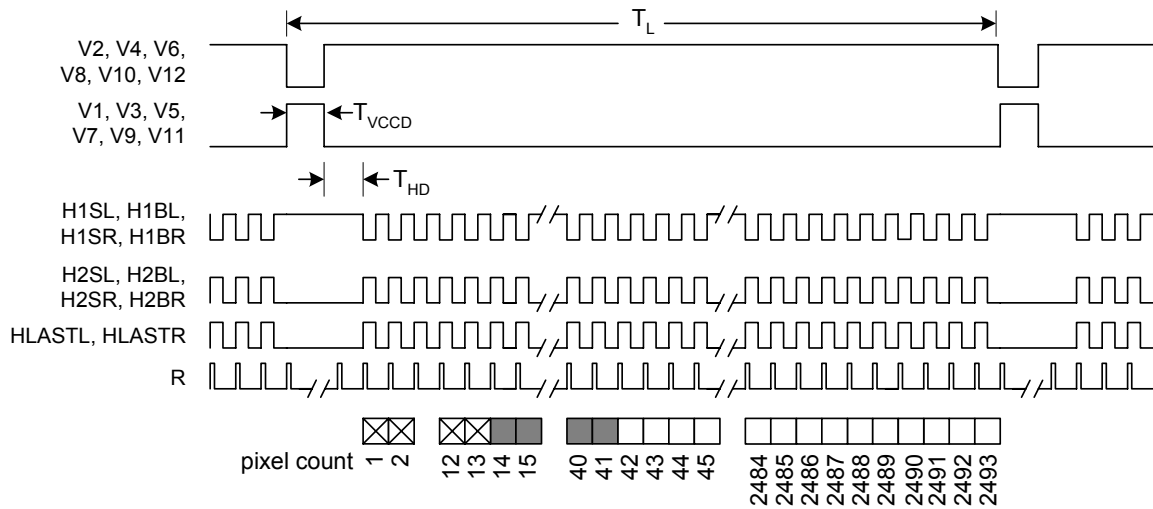

Figure 11: Line Timing Dual Output

Line Timing Detail Single Output

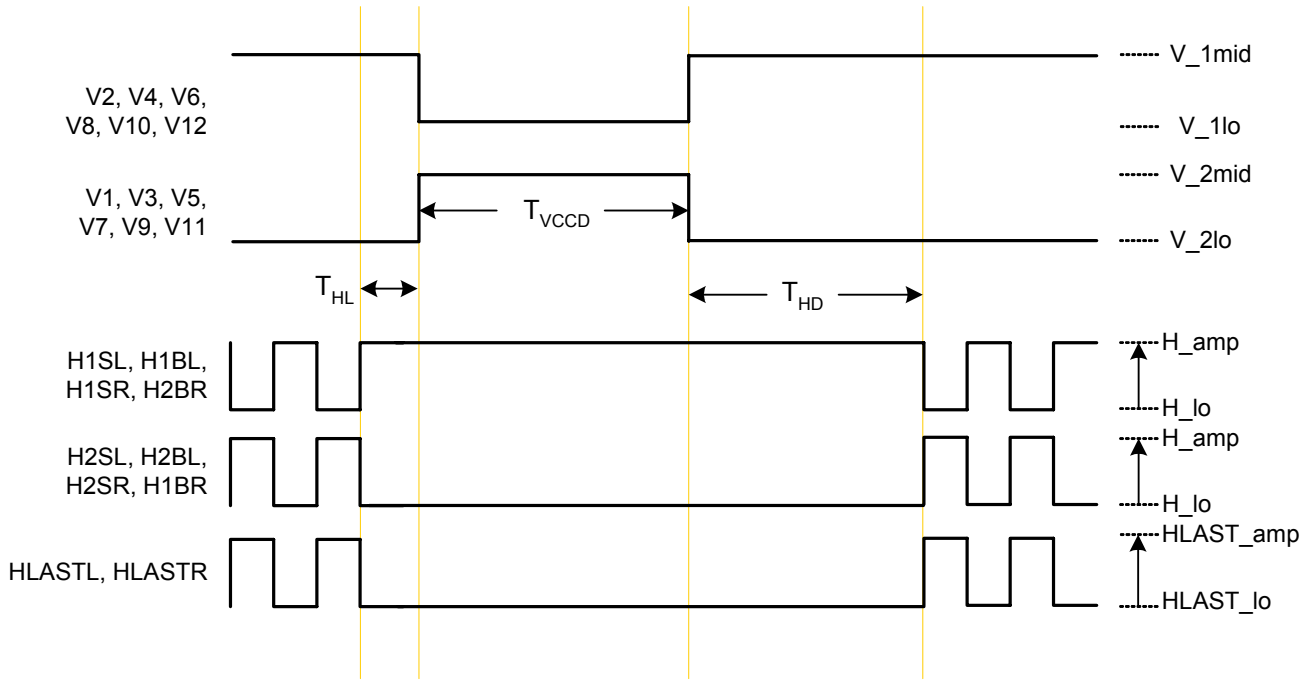

Figure 12: Line Timing Detail Single Output

Line Timing Detail Edge Alignment

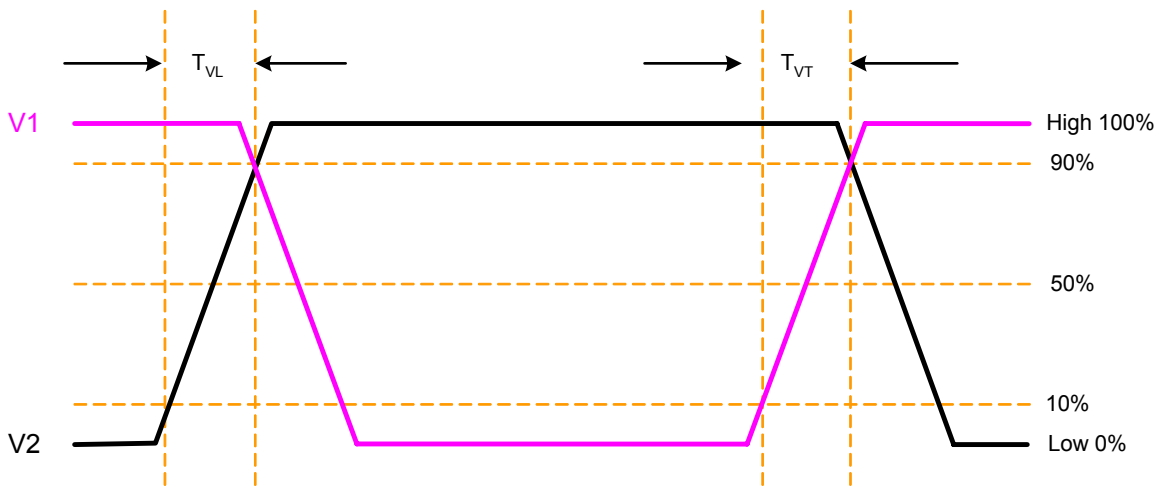

Figure 13: Line Timing Detail Edge Alignment

PIXEL TIMING

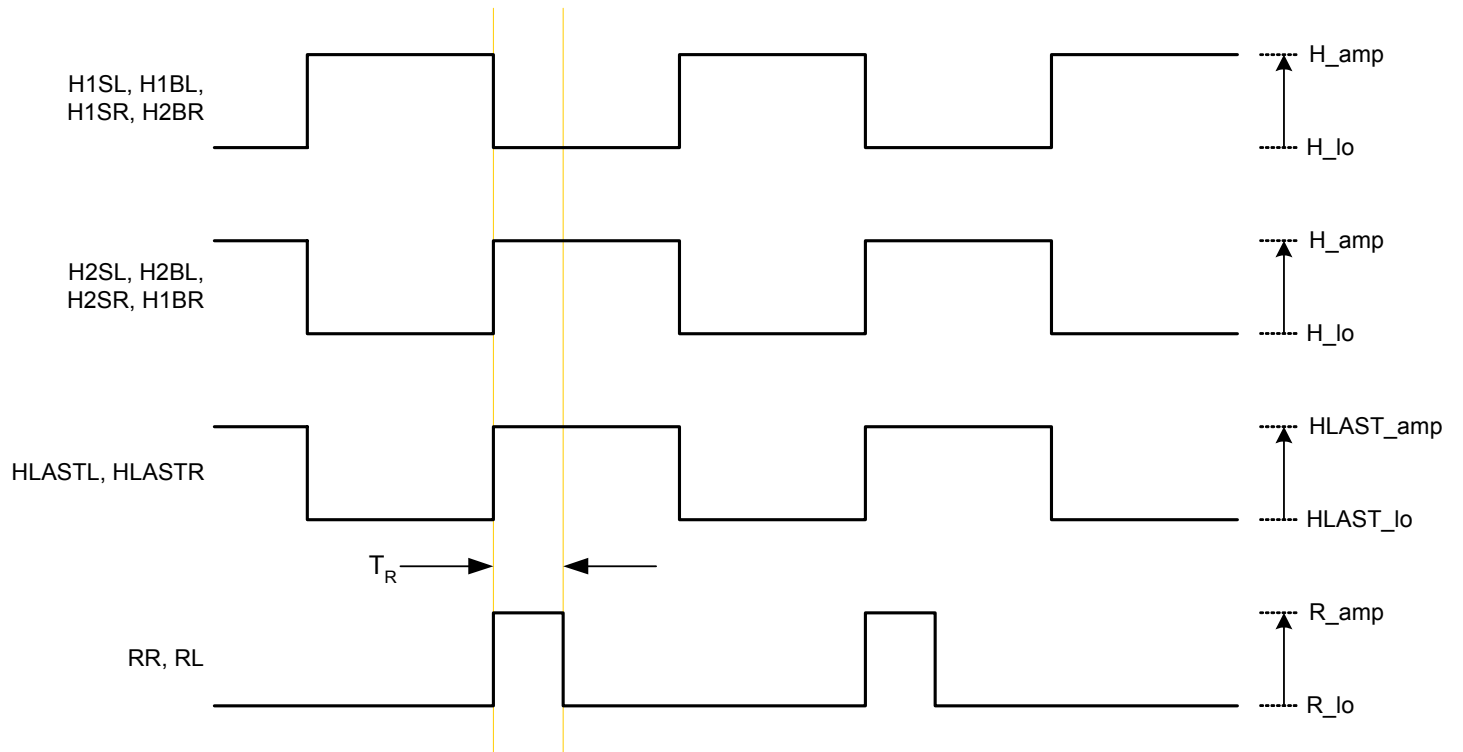

Figure 14: Pixel Timing

FAST LINE DUMP TIMING

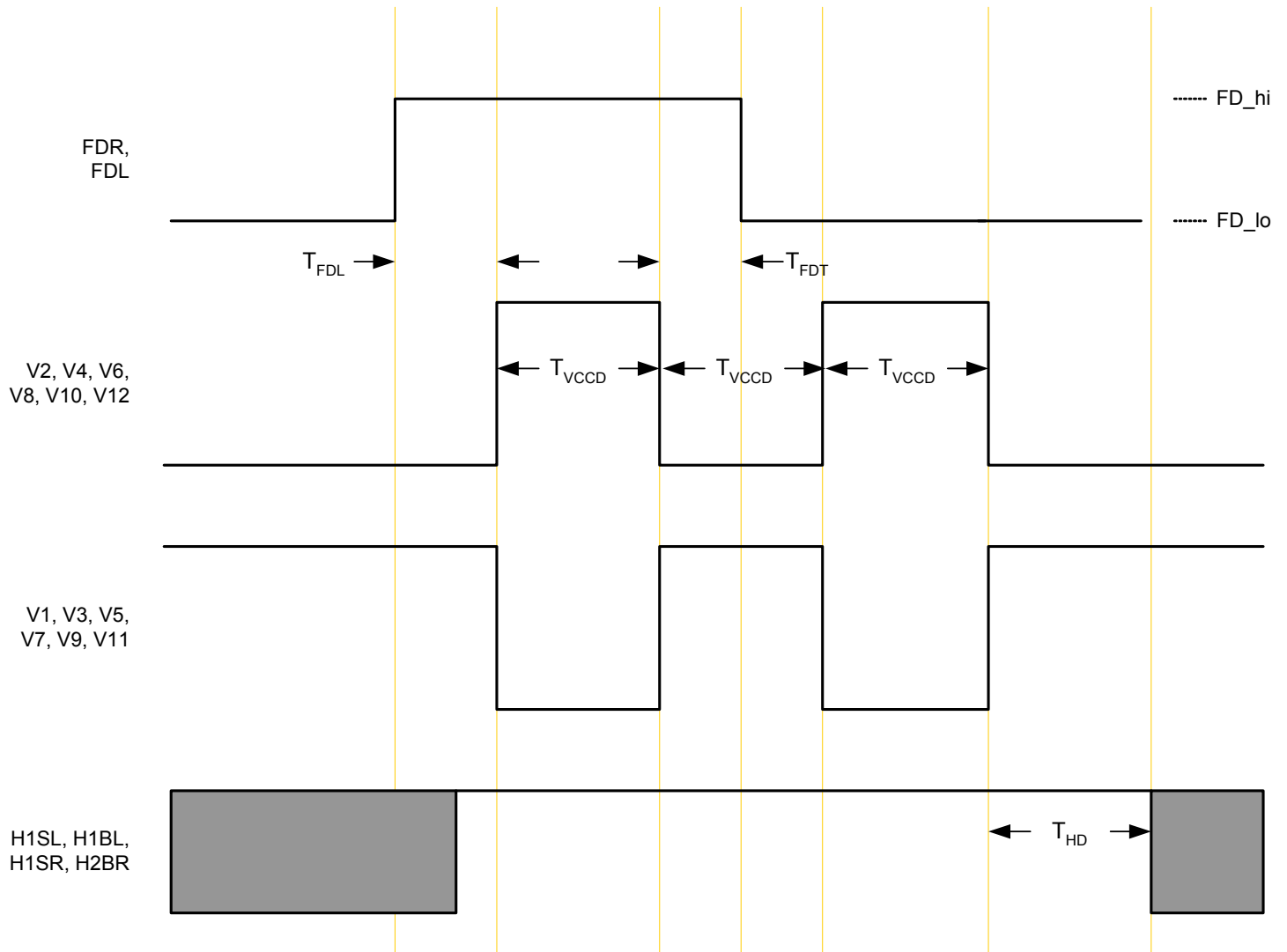

Figure 15: Fast Line Dump Timing

ELECTRONIC SHUTTER TIMING

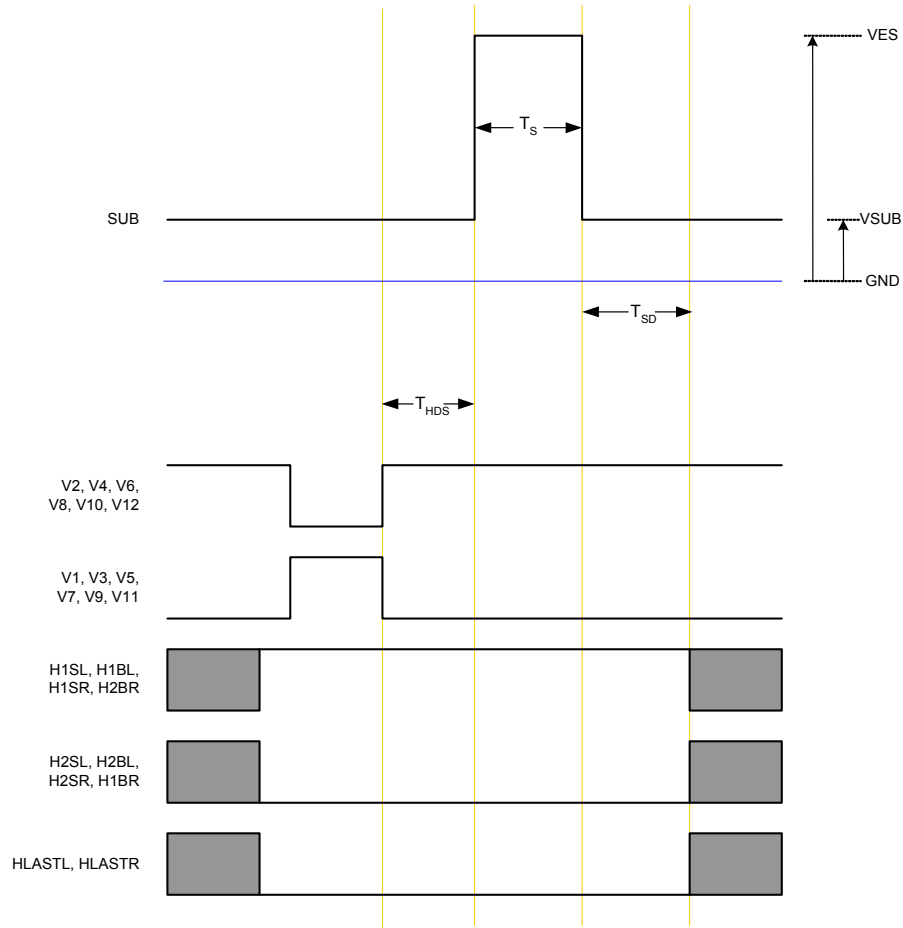

Figure 16: Electronic Shutter Timing

ELECTRONIC SHUTTER INTEGRATION TIME DEFINITION

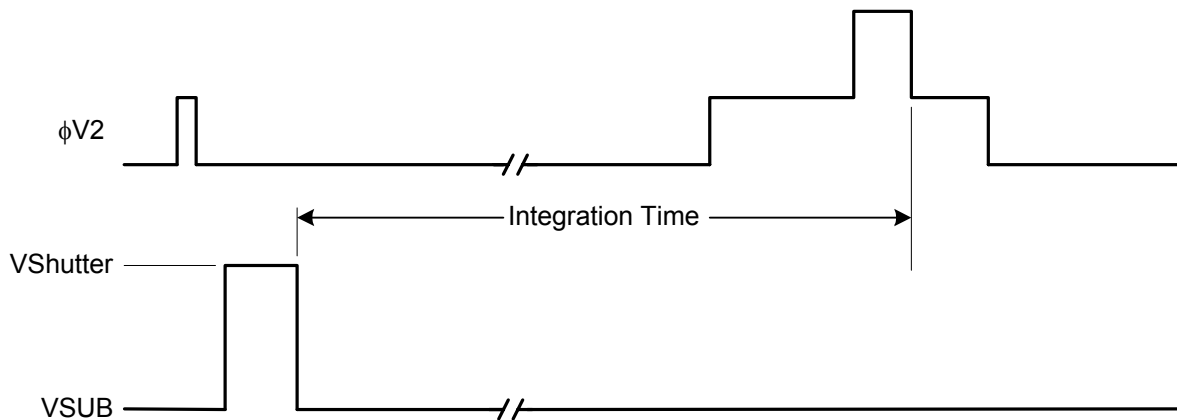

Figure 17: Integration Time Definition

STORAGE AND HANDLING

STORAGE CONDITIONS

Description	Symbol	Minimum	Maximum	Units	Notes
Temperature	T	-55	80	°C	1
Humidity	RH	5	90	%	2

Notes:

1. Long-term exposure toward the maximum temperature will accelerate color filter degradation.
2. T=25°C. Excessive humidity will degrade MTF.

ESD

1. This device contains limited protection against Electrostatic Discharge (ESD). CCD image sensors can be damaged by electrostatic discharge. Failure to do so may alter device performance and reliability.
2. Devices should be handled in accordance with strict ESD procedures for Class 0 (<250V per JESD22 Human Body Model test), or Class A (<200V JESD22 Machine Model test) devices.

Devices are shipped in static-safe containers and should only be handled at static-safe workstations.
3. See Application Note MTD/PS-0224 “Electrostatic Discharge Control for Image Sensors” for proper handling and grounding procedures. This application note also contains recommendations for workplace modifications for the minimization of electrostatic discharge.
4. Store devices in containers made of electro-conductive materials.

COVER GLASS CARE AND CLEANLINESS

1. The cover glass is highly susceptible to particles and other contamination. Perform all assembly operations in a clean environment.
2. Touching the cover glass must be avoided
3. Improper cleaning of the cover glass may damage these devices. Refer to Application Note MTD/PS-0237 “Cover Glass Cleaning for Image Sensors”

ENVIRONMENTAL EXPOSURE

1. Do not expose to strong sun light for long periods of time. The color filters and/or microlenses may become discolored. Long time exposures to a static high contrast scene should be avoided. The image sensor may become discolored and localized changes in response may occur from color filter/microlens aging.
2. Exposure to temperatures exceeding the absolute maximum levels should be avoided for storage and operation. Failure to do so may alter device performance and reliability.
3. Avoid sudden temperature changes.
4. Exposure to excessive humidity will affect device characteristics and should be avoided. Failure to do so may alter device performance and reliability.
5. Avoid storage of the product in the presence of dust or corrosive agents or gases.

Long-term storage should be avoided. Deterioration of lead solderability may occur. It is advised that the solderability of the device leads be re-inspected after an extended period of storage, over one year.

SOLDERING RECOMMENDATIONS

1. The soldering iron tip temperature is not to exceed 370°C. Failure to do so may alter device performance and reliability.
2. Flow soldering method is not recommended. Solder dipping can cause damage to the glass and harm the imaging capability of the device. Recommended method is by partial heating. Kodak recommends the use of a grounded 30W soldering iron. Heat each pin for less than 2 seconds duration.

MECHANICAL DRAWINGS

COMPLETED ASSEMBLY

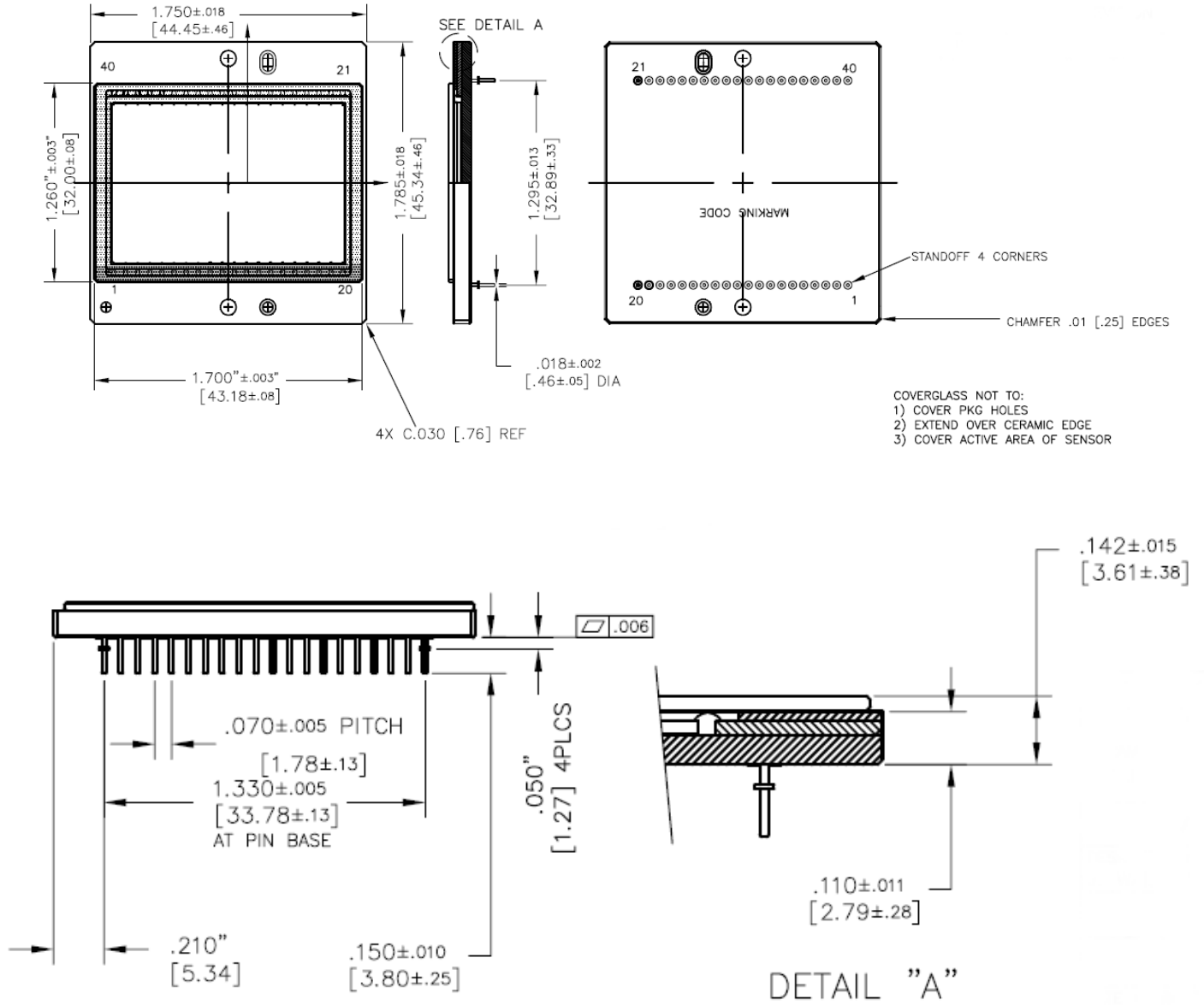

Figure 18: Completed Assembly (1 of 2)

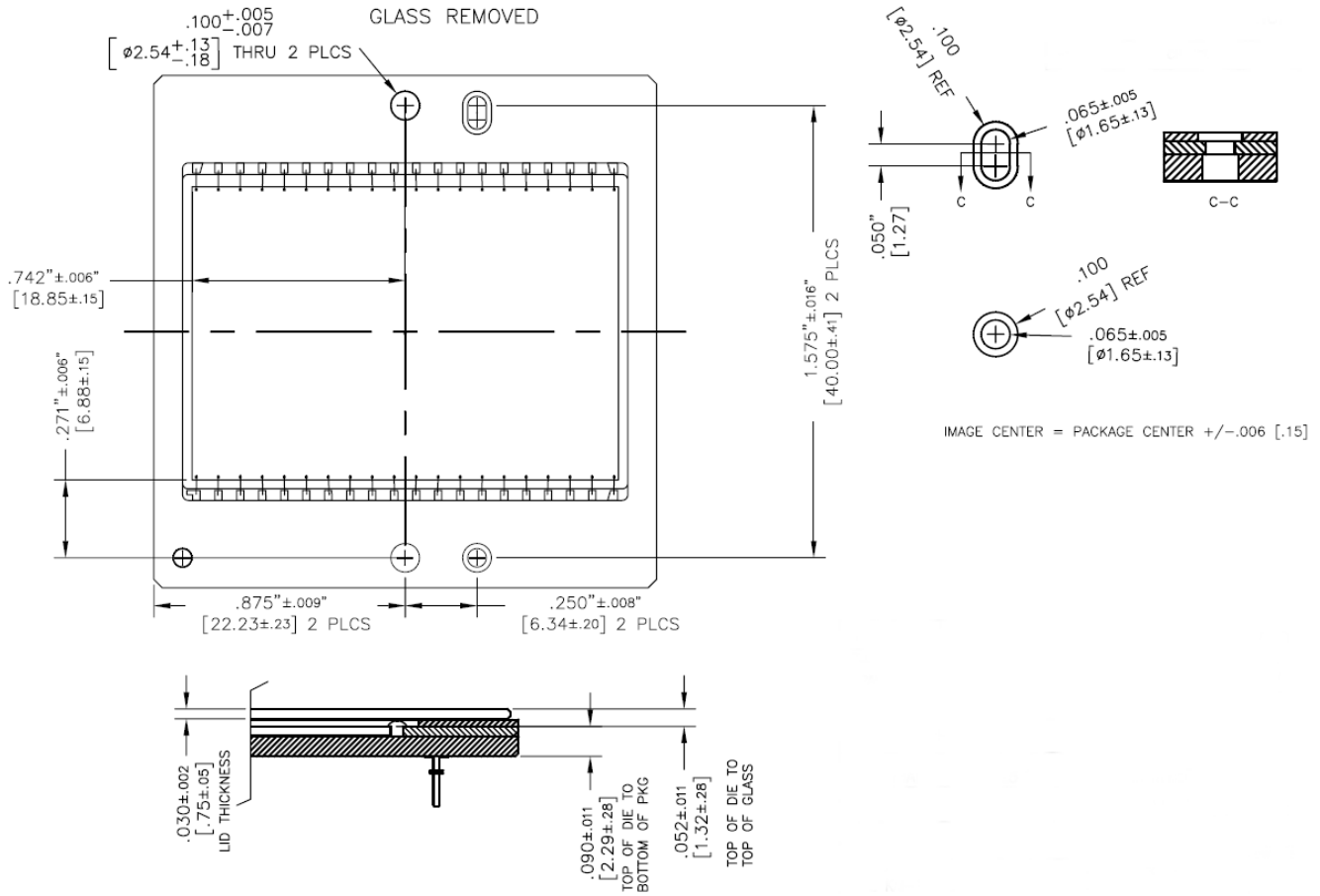
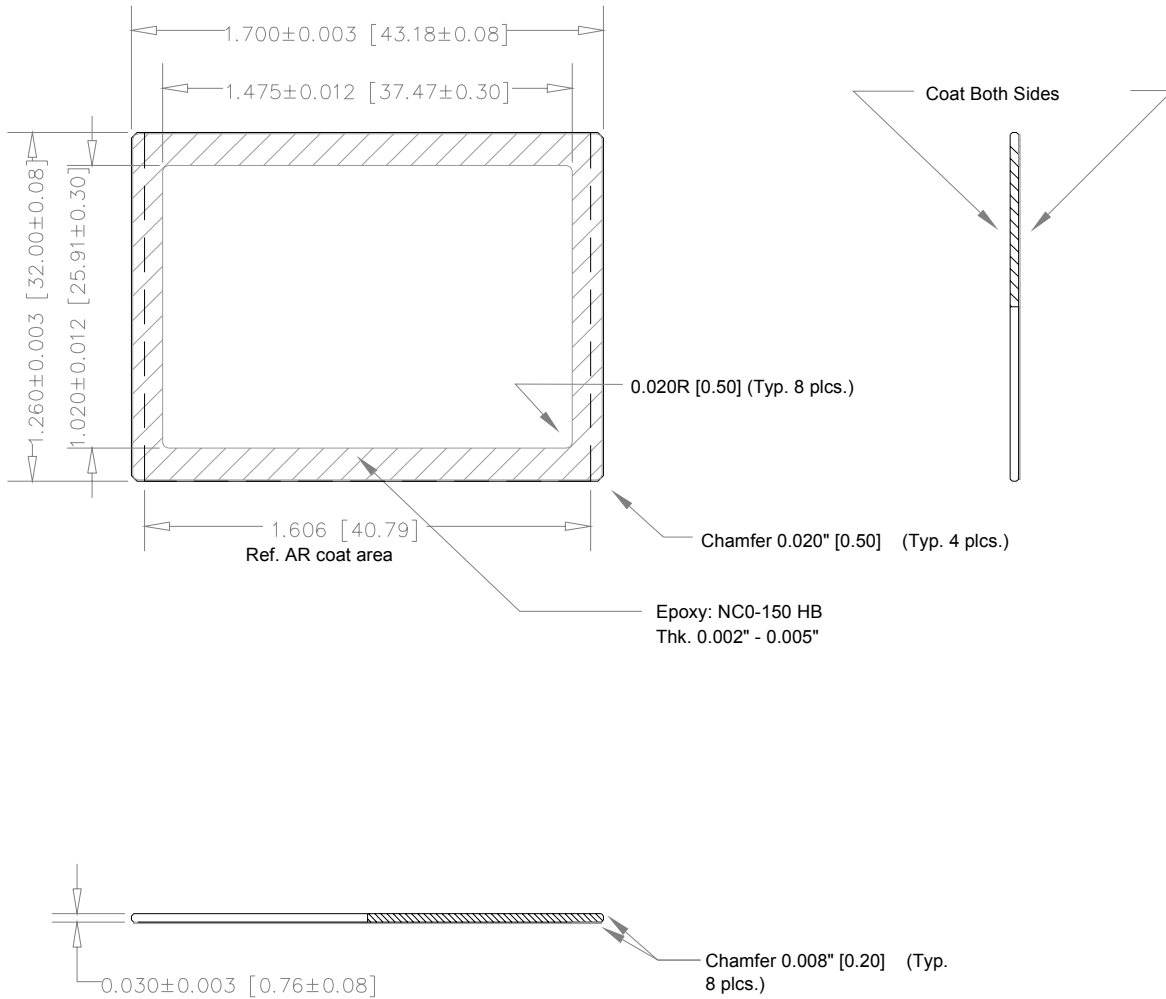

Figure 19: Completed Assembly (2 of 2)

COVER GLASS



NOTES:

1. Multi-Layer Anti-Reflective Coating on 2 sides:
Double Sided Reflectance:
Range (nm)
420 - 450 nm < 2%
450 - 630 nm < 1%
630 - 680 nm < 2%
2. Dust, Scratch specification - 20 microns max.
3. Substrate - Schott D-263 or Equivalent
4. Epoxy: NCO-150HB
Thickness: 0.002" - 0.005"

Figure 20: Glass Drawing

GLASS TRANSMISSION

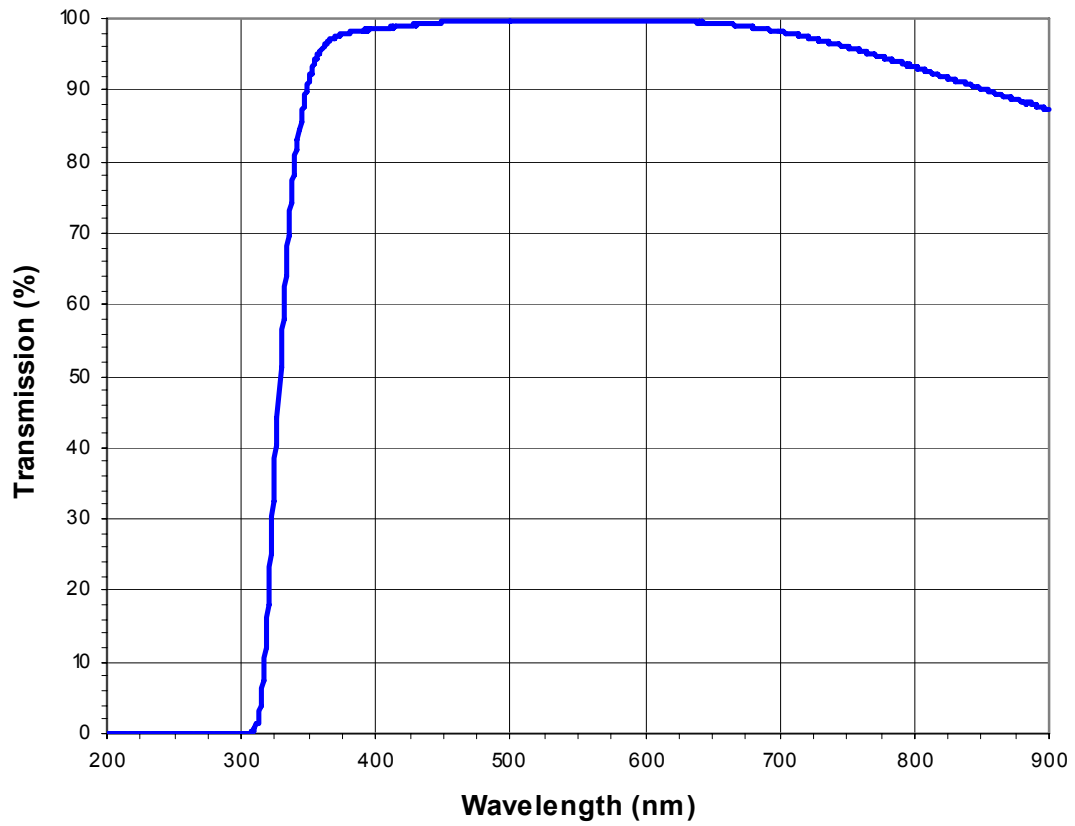

Figure 21: Glass Transmission

QUALITY ASSURANCE AND RELIABILITY

QUALITY STRATEGY

All image sensors will conform to the specifications stated in this document. This will be accomplished through a combination of statistical process control and inspection at key points of the production process. Typical specification limits are not guaranteed but provided as a design target. For further information refer to ISS Application Note MTD/PS-0292, Quality and Reliability.

REPLACEMENT

All devices are warranted against failure in accordance with the terms of Terms of Sale. This does not include failure due to mechanical and electrical causes defined as the liability of the customer below.

LIABILITY OF THE SUPPLIER

A reject is defined as an image sensor that does not meet all of the specifications in this document upon receipt by the customer.

LIABILITY OF THE CUSTOMER

Damage from mechanical (scratches or breakage), electrostatic discharge (ESD) damage, or other electrical misuse of the device beyond the stated absolute maximum ratings, which occurred after receipt of the sensor by the customer, shall be the responsibility of the customer.

Kodak reserves the right to change any information contained herein without notice. All information furnished by Kodak is believed to be accurate.

WARNING: LIFE SUPPORT APPLICATIONS POLICY

Kodak image sensors are not authorized for and should not be used within Life Support Systems without the specific written consent of the Eastman Kodak Company. Product warranty is limited to replacement of defective components and does not cover injury or property or other consequential damages.

REVISION CHANGES

Revision Number	Description of Changes
1.0	Initial release

RELIABILITY

Information concerning the quality assurance and reliability testing procedures and results are available from the Image Sensor Solutions and can be supplied upon request. For further information refer to ISS Application Note MTD/PS-0292, Quality and Reliability.

TEST DATA RETENTION

Image sensors shall have an identifying number traceable to a test data file. Test data shall be kept for a period of 2 years after date of delivery.

MECHANICAL

The device assembly drawing is provided as a reference. The device will conform to the published package tolerances.

This page intentionally left blank.

